

PLEASE READ THIS MANUAL IN ITS ENTIRETY PRIOR TO USING THIS PRODUCT!



OL' MAN TREESTANDS 20' OL' TIMER GRAND DELUXE LADDER (COMB05) INSTRUCTION MANUAL

MEMBER OF



TREESTAND MANUFACTURERS ASSOCIATION



OL' MAN TREESTANDS 20 FT. OL' TIMER GRAND DELUXE LADDER

This Instruction Manual complies with the Treestand Manufacturers Association's TMS 04-98 Revision G - "Standard Practice for Treestand Instructions" and TMS 06-02 Revision B - "Standard Test Method for Treestand Fall Arrest Systems."



WARNING! THIS PRODUCT CARRIES STRICT WEIGHT LIMITATIONS. DO NOT USE THIS PRODUCT IF YOU EXCEED THIS TOTAL WEIGHT LIMITATION. PLEASE NOTE THIS WEIGHT LIMIT INCLUDES THE USER AND EQUIPMENT. FAILURE TO FOLLOW THESE INSTRUCTIONS MAY RESULT IN SERIOUS INJURY OR DEATH!

Model Number #COMB05

Maximum Weight Capacity - 350 pounds (159kg) (Users and Equipment)

WATCH THE DVD!

A SAFE TREESTAND HUNTING VIDEO HAS BEEN INCLUDED. PLEASE VIEW IT IN ITS ENTIRETY PRIOR TO USING THIS PRODUCT!

THANK YOU FOR YOUR PURCHASE OF THIS QUALITY OL' MAN TREESTANDS PRODUCT! TO ENSURE YOUR PERSONAL SAFETY, PLEASE TAKE A MOMENT TO CAREFULLY READ THIS PRODUCT INSTRUCTION MANUAL IN ITS ENTIRETY BEFORE ATTEMPTING TO SET-UP, INSTALL AND/OR OTHERWISE USE THIS OL' MAN TREESTANDS PRODUCT. FAILURE TO DO SO COULD RESULT IN SERIOUS PERSONAL INJURY OR DEATH! THIS OL' MAN TREESTANDS PRODUCT HAS BEEN DESIGNED, ENGINEERED AND MANUFACTURED TO PROVIDE YOU WITH YEARS OF TROUBLE FREE SERVICE.

Should you have any questions about the installation and/or use of this product, or any other Ol' Man Treestands product(s) do not hesitate to call one of our customer service representatives toll free at 888-656-2606. Our service representatives will answer any questions you may have about any of the complete line of Ol' Man Treestands products.

THE FULL-BODY FALL ARREST HARNESS INCLUDED WITH YOUR NEW OL' MAN TREESTANDS TREESTAND HAS A SERVICE LIFE OF THREE (3) YEARS PAST ITS DATE OF MANUFACTURE. THIS DATE OF MANUFACTURE CAN BE FOUND ON THE SEWN ON LABEL OF EACH COMPONENT OF THE FALL ARREST SYSTEM. REPLACE THIS HARNESS IF THE SERVICE LIFE HAS EXPIRED. SHOULD YOU EXPERIENCE A FALL WHILE WEARING YOUR FULL BODY FALL ARREST HARNESS RETURN IT TO THE MANUFACTURER FOR FREE REPLACEMENT. YOU MUST READ THE SCOUT, INC. FULL-BODY FALL ARREST SYSTEM (FAS) INSTRUCTION MANUAL IN IT'S ENTIRETY PRIOR TO ATTEMPTING TO USE THIS OL' MAN TREESTANDS PRODUCT(S) IN ANY MANNER.

PLEASE READ THIS MANUAL IN ITS ENTIRETY PRIOR TO USING THIS PRODUCT!

PLEASE READ THIS MANUAL IN ITS ENTIRETY PRIOR TO USING THIS PRODUCT!

PLEASE READ THIS MANUAL IN ITS ENTIRETY PRIOR TO USING THIS PRODUCT!

PLEASE READ THIS MANUAL IN ITS ENTIRETY PRIOR TO USING THIS PRODUCT!

ATTENTION!!

WHEN YOU SEE A "WARNING!" BE SURE TO HEED THE MESSAGE! THE INFORMATION CONTAINED IN THESE MESSAGES CAN SAVE YOUR LIFE!!



 **WARNING!** FALLS FROM A TREESTAND CAN OCCUR ANYTIME AFTER LEAVING THE GROUND. THESE FALLS RESULT IN EITHER SERIOUS INJURY OR DEATH! FOR YOUR PERSONAL SAFETY, PLEASE TAKE A MOMENT TO CAREFULLY READ THIS PRODUCT INSTRUCTION MANUAL IN ITS ENTIRETY BEFORE ATTEMPTING TO ASSEMBLE, SET-UP, INSTALL AND/OR OTHERWISE USE THIS OL' MAN TREESTANDS PRODUCT. AT LEAST ANNUALLY, REVIEW THE CONTENTS OF THIS INSTRUCTION MANUAL AND WATCH THE SAFE TREESTAND HUNTING DVD. ADDITIONALLY, KEEP THESE INSTRUCTIONS FOR THE ENTIRE DURATION THAT YOU OWN THIS PRODUCT(S). FAILURE TO FOLLOW THESE INSTRUCTIONS MAY RESULT IN SERIOUS INJURY OR DEATH!



WARNING! THE SAFE USE AND OPERATION OF THIS PRODUCT IS THE SOLE RESPONSIBILITY OF THE USER. IT IS ALSO THE SOLE RESPONSIBILITY OF THE OWNER TO PROVIDE ANY PERSON(S) WHO BORROW OR PURCHASE THIS PRODUCT FROM THEM WITH THESE INSTRUCTIONS AND THE AFORE MENTIONED SAFE TREESTAND HUNTING VIDEO. FAILURE TO FOLLOW THESE INSTRUCTIONS MAY RESULT IN SERIOUS INJURY OR DEATH! ADDITIONALLY, FAILURE TO FOLLOW THESE INSTRUCTIONS MAY SUBJECT YOU TO PERSONAL LIABILITY PENALTIES AS DETERMINED BY THE U.S. JUDICIAL SYSTEM.



WARNING! Prior to each hunt, make sure that you have a signaling device (e.g., mobile phone, radio, whistle, signal flare, Personal Locator Device [PLD], etc.) in your possession and on your person in an operable condition. This device must be within easy access should you experience the need to contact emergency assistance. Failure to follow these instructions may result in serious injury or death!



WARNING! Failure to read and strictly comply with the instructions contained in this Instruction Manual may result in serious injury or death!



PLEASE NOTE THAT "WARNING!" Statements have been placed throughout this Instruction Manual. These statements point-out important safety information and instructions, which, if not followed could endanger the personal safety and/or property of the operator. It is imperative that the operator of this product, or any other Ol' Man Treestands product(s) read and understand all the instructions and warnings contained in this Instruction Manual prior to attempting to use this product(s), or any other Ol' Man Treestands product(s). Failure to comply with these instructions and/or warnings may result in serious injury or death! When you see a "WARNING!" Statement- BE SURE TO HEED THE MESSAGE!



WARNING! Thoroughly inspect this or any other Ol' Man Treestands product(s) prior to each use for signs of wear, rot, corrosion, cracks, deterioration and/or any other type or defect. DO NOT expose this product or your treestand to extended exposure to direct sunlight, excessive heat or freezing temperatures. Do not use your treestand or this or any other Ol' Man Treestands product(s) if they show evidence of wear, rot, corrosion, cracks, deterioration and/or any other type of defect. Failure to follow these instructions may result in serious injury or death!



WARNING! Do not remove, modify and/or omit any portion or otherwise mechanically modify this Ol' Man Treestands product(s) or its assemblies in any manner. Modification, misuse and/or part substitution shall immediately void your factory warranty and may result serious injury or death! If you suspect that a part(s) is missing and/or defective, immediately contact Ol' Man Treestands at 888-656-2606 for replacement of missing or defective parts. Never modify your stand in any way by making repairs, or altering, adding or attaching anything to it except if explicitly authorized in writing by OL' MAN TREESTANDS. ALWAYS USE GENUINE FACTORY AUTHORIZED OL' MAN TREESTANDS REPLACEMENT PARTS. USE OF ANY REPLACEMENT PARTS OTHER THAN GENUINE OL' MAN TREESTANDS PARTS VOIDS YOUR WARRANTY AND MAY RESULT IN SERIOUS INJURY OR DEATH!



WARNING! This Ol' Man Treestands product(s) is designed for adult use only. No one under the age of 16 should attempt to use this or any other Ol' Man Treestands product(s) without direct adult supervision. Failure to follow these instructions may result in serious injury or death!



WARNING! Prior to attempting to use this or any other Ol' Man Treestands product(s) you must take a moment and become familiar with its assembly, setup and installation. You must practice installing, setting-up and using this product(s) at ground level prior to attempting to use it at heights above ground-level. Once you have become thoroughly knowledgeable and comfortable with this Ol' Man Treestands product(s) set-up, installation and use at ground-level, you are now ready to use it at heights above ground-level. Failure to follow these instructions may result in serious injury and death!

PLEASE READ THIS MANUAL IN ITS ENTIRETY PRIOR TO USING THIS PRODUCT!

PLEASE READ THIS MANUAL IN ITS ENTIRETY PRIOR TO USING THIS PRODUCT!

PLEASE READ THIS MANUAL IN ITS ENTIRETY PRIOR TO USING THIS PRODUCT!

ATTENTION!!

WHEN YOU SEE A "WARNING!" BE SURE TO HEED THE MESSAGE! THE INFORMATION CONTAINED IN THESE MESSAGES CAN SAVE YOUR LIFE!!



WARNING! When hunting from a treestand falls can occur any time after leaving the ground causing injury or death. Always wear your Scout, Inc. full body fall arrest system (FAS) comprising a full-body harness at all times after leaving the ground. You must stay connected at all times after leaving the ground while using climbing and hang-on treestands. Single safety belts and chest harnesses are no longer allowed and should never be used as they put the user at serious risk of injury or death. If you are not wearing your full-body harness properly attached to the tree that is protecting you from a fall, do not leave the ground. Failure to follow these instructions may result in serious injury or death!



WARNING! Never rely on a tree branch for support while climbing. Failure to follow these instructions may result in serious injury or death!



WARNING! You must always inform someone of your hunting location, where the treestand will be located and the expected duration of the hunt. Failure to follow these instructions may result in serious injury or death!



WARNING! Inspect all safety devices and equipment every time prior to each use. DO NOT use these devices if it (they) shows signs of wear, damage, deterioration, or vandalism. Factors such as tree growth, vandals, weather and animals may affect the performance of an unattended tree stand. Do not store these devices outdoors when not in use. Failure to follow these instructions may result in serious injury or death!



WARNING! Practice the use your Scout, Inc. full-body fall arrest harness at ground level in the presence of a responsible adult to experience the feeling of hanging suspended before using in a hunting environment. Failure to follow these instructions may result in serious injury or death!



WARNING! The length of the full-body fall arrest lanyard must be minimized at all times. It should be adjusted so that it is above the head with no slack (snug) in the sitting position and you should have the minimum amount of slack possible when climbing. Failure to follow these instructions may result in serious injury or death!



WARNING! If your hunting location is unknown by anyone and communication efforts are unsuccessful, you must have a personal plan for self-recovery/escape should you experience a fall. Prolonged suspension in a harness can be fatal. It is important to exercise the legs by pushing against the tree or doing other forms of continuous leg exercises to avoid blood pooling while being suspended. Varying degrees of physical fitness may require different plans for self-recovery/escape the effects of prolonged suspension. Have a personal plan and practice it in the presence of a responsible adult before leaving the ground. No one escape/rescue plan will work for every hunter, on every tree, in every circumstance. Only you can determine the best self-recovery/escape plan for your hunting situation and you must have a self-recovery/escape plan for your individual situation before leaving the ground. There is time to make a correct decision on what action to take if a fall occurs while wearing a full body harness. It is important to remember, "DO NOT PANIC." You must only hunt from the ground when self-recovery/escape ability is absent. Failure to follow these instructions may result in serious injury or death!



WARNING! A suspension relief device must be on your person and readily accessible while using your full-body fall arrest harness. This device will allow you to relieve the load on the lower extremities if suspended in your harness and help maintain circulation in the legs and prevent suspension trauma (blood pooling). Be sure to follow the SCOUT, Inc. directions for use of this suspension relief device. Failure to follow these instructions may result in serious injury or death!



WARNING! If you have a limiting physical and/or health condition that precludes and/or renders you incapable of self-recovery and/or a suitable escape plan is not available, DO NOT hunt from heights above ground level. Failure to follow these instructions may result in serious injury or death!



WARNING! NEVER allow the harness lanyard to get under your chin or around your neck. This poses a choking hazard that can lead to serious injury or death. Failure to follow these instructions may result in serious injury or death!



WARNING! Never attempt to climb up or climb down with a weapon and/or gear in your possession. ALWAYS unload your weapon and pull it up to hunting height using a tether or pull up rope. ALWAYS lower your unloaded weapon down to the ground prior (when raising or lowering firearms, the chamber must be open and the barrel pointing toward the ground) to attempting to climb down. Use this same method when raising or lowering all other gear. Failure to follow these instructions may result in serious injury or death!



WARNING! DO NOT attempt to use this and/or any other Ol' Man Treestands product(s) when ice, snow and/or freezing rain has deposited or formed on any portion of the tree you intend to climb. Failure to follow these instructions may result in serious injury or death!

ATTENTION!!

WHEN YOU SEE A "WARNING!" BE SURE TO HEED THE MESSAGE! THE INFORMATION CONTAINED IN THESE MESSAGES CAN SAVE YOUR LIFE!!



WARNING! ALWAYS maintain three-point contact when climbing up/down a tree when using climbing aids. Proper three-point contact means having either two feet with one hand or one foot with two hands on the step portion of the climbing aid at all times when climbing up or down. Failure to follow these instructions may result in serious injury or death!



WARNING! DO NOT modify, fix/repair, alter, bend, cut, weld, or heat this product in any way. Failure to follow these instructions will void warranty and may result in serious injury or death!



WARNING! DO NOT lean out from a tree stand for any reason. Never use your Scout, Inc. full-body fall arrest harness to help you lean out of your stand to make a difficult shot. Failure to follow these instructions may result in serious injury or death!



WARNING! DO NOT use this or any other Ol' Man Treestands product(s) if you have a history of heart problems, back problems, impaired vision, joints that lock-up, spinal fusions, equilibrium problems, high blood pressure, are not well-rested and/or any other physical impairment that may limit your ability to use and/or operate this product(s) in the safe manner outlined in this Instruction Manual. Additionally, do not use this or any other Ol' Man Treestands product(s) if you are currently taking any medication (including prescription) and/or using and/or consuming any substance, including alcohol, that may limit your ability to use this Ol' Man Treestands product(s) as outlined and described in the Instruction Manual. Never use a treestand when feeling ill, nauseous or dizzy. Failure to follow these instructions may result in serious injury or death!



WARNING! DO NOT attempt to use this or any other Ol' Man Treestands product(s) when thunderstorms are threatening and/or present within five (5) miles. Do not attempt to use this or any other Ol' Man Treestands product(s) when any other adverse weather condition presents itself. These include weather conditions which have the potential for producing winds, lightning, rain, snow, sleet and/or any other atmospheric condition which may limit the user's ability to operate this Ol' Man Treestands product(s) in a safe manner as described in this Instruction Manual. Should inclement weather conditions arise during your use of this Ol' Man Treestands product(s), return to the ground immediately. Failure to follow these instructions may result in serious injury and death!



WARNING! DO NOT use this product, or attempt to use a treestand, on a dead, leaning, diseased, loose barked tree (bark that flakes or falls off), irregular shaped trees, or utility pole. DO NOT use this product on any tree that does not allow for a level standing platform. Failure to follow these instructions may result in serious injury or death!



WARNING! Never jump or bounce on a treestand to seat it to the tree. Failure to follow these instructions may result in serious injury or death!

SPECIAL CONSIDERATIONS FOR LADDER TREESTAND USAGE



WARNING! You must use at least three (3) adults to install and/or take down this ladder treestand. Failure to follow these instructions may result in serious injury or death!



WARNING! You must install and attach the criss cross straps and other stabilization devices as described in this Manual prior to attempting to climb this treestand. Failure to follow these instructions may result in serious injury or death!



WARNING! When installing this ladder treestand you must bounce on the first rung to set the ladder into the ground prior to attempting to climb any higher. Failure to follow these instructions may result in serious injury or death!



WARNING! You must check every ladder section connection every time you use the stand before you leave the ground. If you find that the ladder sections are separating, DO NOT USE the treestand. Failure to follow these instructions may result in serious injury or death!



WARNING! You must check the ground under the treestand to make sure it is firm and level. Sloping ground or uneven surfaces (e.g., one foot on a rock) can cause your ladder to tilt or shift off the tree as you climb. Failure to follow these instructions may result in serious injury or death!



WARNING! You must maintain three-points of contact when climbing a ladder treestand (i.e., two feet-one hand, two hands-one foot). Failure to follow these instructions may result in serious injury or death!



WARNING! You must always lean forward as you climb and attach your full-body fall arrest harness to the tree before securing the platform to the tree and stepping onto the standing platform. Failure to follow these instructions may result in serious injury or death!



SCOUT, INC. FULL-BODY FALL ARREST HARNESS SYSTEM (FAS)

We are very serious about your personal safety. A Scout, Inc. full-body fall arrest harness has been included with this product for your use. The Scout full-body fall arrest harness has been designed to keep you from experiencing a fall. Remember, the most important part of your hunt is returning home to your family safe and sound.

READ THE SCOUT FULL-BODY FALL ARREST HARNESS MANUAL CAREFULLY AND FOLLOW ALL THE INSTRUCTIONS! YOUR NEW FULL-BODY FALL ARREST HARNESS IS DESIGNED FOR A MAXIMUM CAPACITY OF 350 POUNDS (159kg). ADDITIONALLY - YOUR NEW FULL-BODY FALL ARREST HARNESS MUST BE REPLACED AFTER THREE (3) YEARS OF SERVICE! RETURN YOUR HARNESS TO THE MANUFACTURER FOR FREE REPLACEMENT SHOULD YOU EXPERIENCE A FALL.



WARNING! Use only the TMA compliant full-body fall arrest harness that was provided with this product. **NOTE: You must store your full-body harness out of direct sunlight and out of any other harsh environmental condition(s) that may adversely affect its performance.** Failure to follow these instructions may result in serious injury or death!

OL' MAN TREESTANDS 20 FT. OL' TIMER GRAND DELUXE ASSEMBLY

Prior to installing and using your Ol' Man Treestands treestand you must perform some assembly.

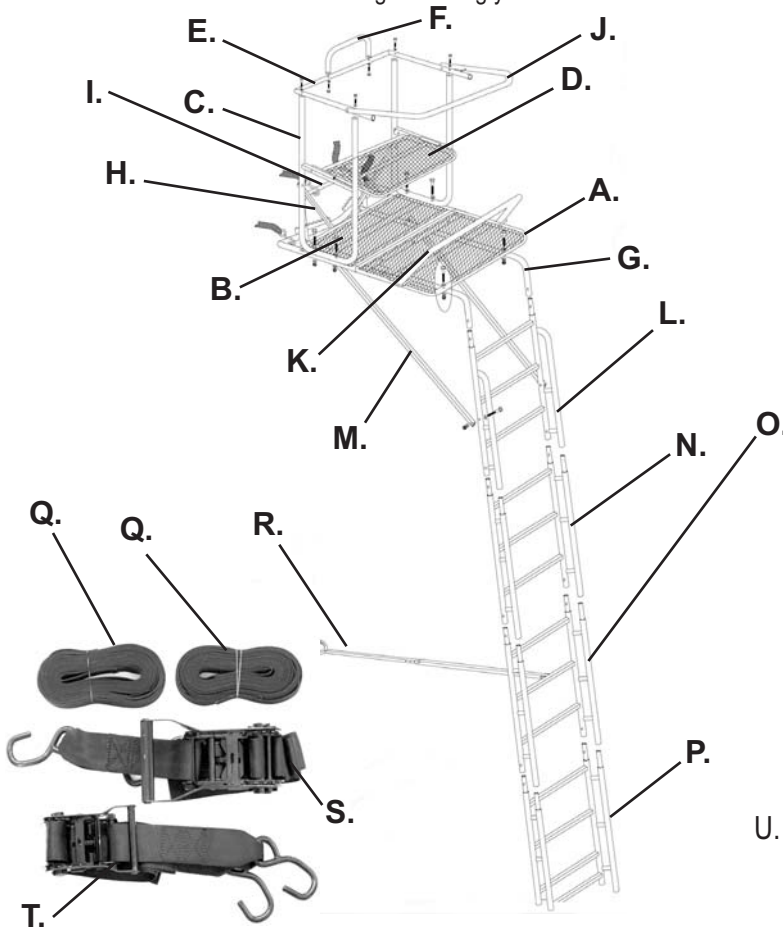

- A. Male Standing Platform Section
- B. Female Standing Platform Section
- C. (2) U-Brace Supports (one labeled)
- D. Seating Platform
- E. Top Rail
- F. Seat Support
- G. (2) Ladder Supports (one labeled)
- H. (2) Rear Diagonal Braces (on labeled)
- I. Upper Tree Brace
- J. Shooting Rail
- K. Footrest
- L. Upper Ladder Section
- M. (2) Diagonal Ladder Braces (one labeled)
- N. Second Ladder Section
- O. Ladder Section w/ Stabilizer Bar Bracket
- P. Lower Ladder Section
- Q. Criss Cross Safety Straps
- R. Tree Stabilizer Bar
- S. 4" Ratchet Strap
- T. 3 1/4" Ratchet Strap
- U. SCOUT Full Body Fall Arrest Harness



U. SCOUT Full-Body Fall Arrest Harness

FIGURE 1
COMPONENTS OF 20' OL' TIMER GRAND DELUXE LADDER

STEP 1: Refer to Figure 1. Locate the male standing platform section (A.) and the female standing platform section (B.). Insert the male standing platform section (A.) into the female standing platform section (B.) as shown in Figure 2.

STEP 2: With the two (2) platforms mated together, secure using three (3) 3" x 5/16" bolts, six (6) washers and three (3) locknuts as shown in Figure 3. Tighten using two (2) 13mm wrenches (not included).

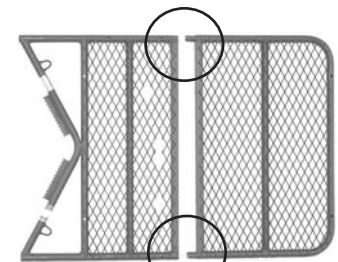

FIGURE 2
MATE STANDING PLATFORM TOGETHER

PLEASE READ THIS MANUAL IN ITS ENTIRETY PRIOR TO USING THIS PRODUCT!

PLEASE READ THIS MANUAL IN ITS ENTIRETY PRIOR TO USING THIS PRODUCT!

PLEASE READ THIS MANUAL IN ITS ENTIRETY PRIOR TO USING THIS PRODUCT!

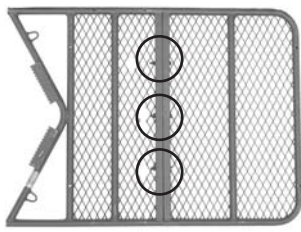

FIGURE 3
BOLT STANDING PLAT-
FORM TOGETHER

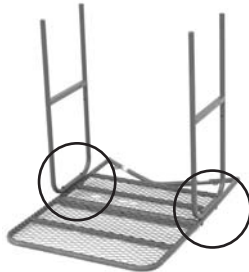

FIGURE 4
INSTALL U-BRACE
SUPPORTS



FIGURE 5
ORIENT SEAT MOUNTING
HOLES TOWARD BACK



FIGURE 6
INSTALL SEATING
PLATFORM

STEP 3: Refer to Figure 1. Locate the two (2) u-brace supports (C.). Install the u-brace supports (C.) onto the standing platform using four (4) 3" x 5/16" bolts, eight (8) washers and four (4) locknuts as shown in Figure 4. Make certain the seat mounting holes are oriented toward the back of the standing platform as shown in Figure 5.

STEP 4: Refer to Figure 1. Locate the seating platform (D.). Install the seating platform (D.) onto the previously installed u-brace supports (C.) as shown in Figure 6. The mounting holes for the seating platform (D.) should be oriented toward the back of the stand as shown in Figure 5. Attach using two (2) 3" x 5/16" bolts, four (4) washers and two (2) locknuts. DO NOT OVERTIGHTEN THESE BOLTS. THE SEATING PLATFORM MUST BE ABLE TO FOLD UP AND DOWN.

STEP 5: Refer to Figure 1. Locate the top rail (E.). Install the top rail (E.) onto the u-brace supports (C.) as shown in Figure 7. Secure using four (4) 1 3/4" x 5/16" bolts and four (4) washers.

STEP 6: Refer to Figure 1. Locate the seat support (F.). Install the seat support (F.) onto the previously installed top rail (E.) as shown in Figure 8. Secure using four (4) 1 3/4" x 5/16" bolts and four (4) washers.

STEP 7: Refer to Figure 1. Locate the two (2) ladder supports (G.). Install the two (2) ladder supports (G.) onto the bottom of the standing platform as shown in Figure 9. Secure each support using two (2) 3" x 5/16" bolts, four (4) washers and two (2) locknuts per ladder support as shown in Figure 9.



FIGURE 7
INSTALL TOP RAIL



FIGURE 8
INSTALL SEAT SUPPORT

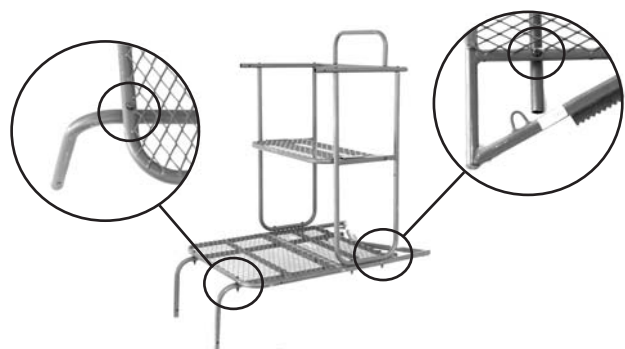

FIGURE 9
INSTALL LADDER SUPPORTS

STEP 8: Refer to Figure 1. Locate the two (2) rear diagonal braces (H.). Install the rear diagonal braces (H.) onto the previously installed u-braces (C.) and the standing platform as shown in Figure 10. Secure the rear diagonal braces (H.) using two (2) 3" x 5/16" bolts, four (4) washers and two (2) locknuts.



FIGURE 10
INSTALL REAR DIAGONAL
BRACES



FIGURE 11
INSTALL UPPER TREE BRACE



FIGURE 12
INSTALL SHOOTING RAIL

STEP 9: Refer to Figure 1. Locate the upper tree brace (I.). Install the upper tree brace (I.) onto the previously installed ladder supports (G.) as shown in Figure 11 using two (2) 3" x 5/16" bolts, four (4) washers and two (2) locknuts.

PLEASE READ THIS MANUAL IN ITS ENTIRETY PRIOR TO USING THIS PRODUCT!

PLEASE READ THIS MANUAL IN ITS ENTIRETY PRIOR TO USING THIS PRODUCT!

PLEASE READ THIS MANUAL IN ITS ENTIRETY PRIOR TO USING THIS PRODUCT!

PLEASE READ THIS MANUAL IN ITS ENTIRETY PRIOR TO USING THIS PRODUCT!

PLEASE READ THIS MANUAL IN ITS ENTIRETY PRIOR TO USING THIS PRODUCT!



FIGURE 13
INSTALL FOOTREST



FIGURE 14
TURN PLATFORM ON SIDE

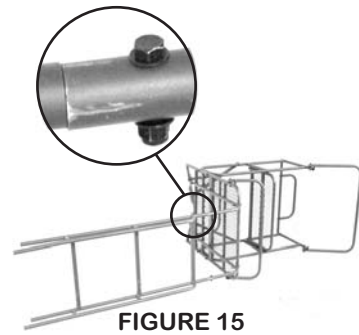

FIGURE 15
INSTALL UPPER LADDER SECTION

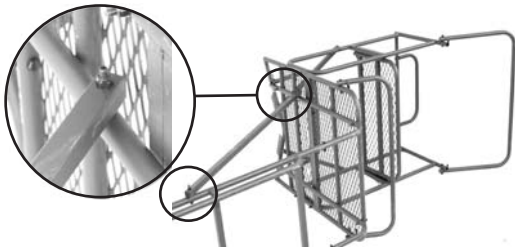

FIGURE 16
INSTALL DIAGONAL LADDER BRACES

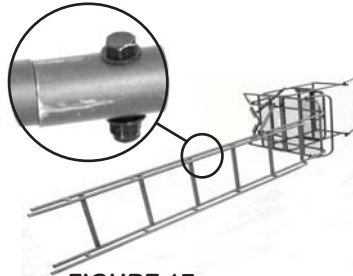

FIGURE 17
SECOND LADDER SECTION INSTALLED

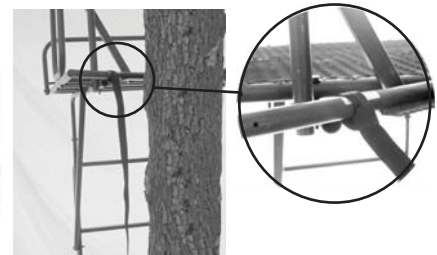

FIGURE 18
INSTALL CRISS CROSS STRAPS

STEP 10: Refer to Figure 1. Locate the shooting rail (J.). Install the shooting rail (J.) onto the previously installed top rail (E.) using two (2) 3" x 5/16" bolts, four (4) washers and two (2) locknuts as shown in Figure 12.

STEP 11: Refer to Figure 1. Locate the footrest (K.). Install the footrest (K.) onto the standing platform as shown in Figure 13. Secure using two (2) 3" x 5/16" bolts, four (4) washers and two (2) locknuts.

STEP 12: You are now finished assembling the standing/seating platform. GO BACK AND MAKE SURE ALL THE HARDWARE IS TIGHT.

STEP 13: Refer to Figure 1. Locate the upper ladder section (L.). With the help of two (2) other adults, gently turn the previously assembled standing/seating platform on its side as shown in Figure 14. Attach the upper ladder section (K.) onto the previously installed two (2) ladder supports (G.) as shown in Figure 15. NOTE: Install the upper ladder section (L.) by inserting the male end into the female end of the two (2) ladder supports (G.) as shown in Figure 15. Secure using two (2) 1 3/4" x 5/16" bolts, four (4) washers and two (2) locknuts.

STEP 14: Refer to Figure 1. Locate the two (2) diagonal ladder braces (M.). Install the two (2) diagonal ladder braces onto the previously installed two (2) ladder supports (G.) and the upper ladder section (K.) as shown in Figure 16. Secure using two (2) 3" x 5/16" bolts, four (4) washers and two (2) locknuts per diagonal ladder brace (M.). Make certain the diagonal ladder braces (M.) are positioned on the outside of the ladder supports (G.) and upper ladder section (K.).

STEP 15: Refer to Figure 1. Locate the second ladder section (N.). Install the second ladder section (N.) onto the previously installed upper ladder section (L.) by inserting the male end of the second ladder section (N.) into the female portion of the upper ladder section (L.). Secure using two (2) 1 3/4" x 5/16" bolts, four washers and two (2) locknuts as shown in Figure 17.

STEP 16: Refer to Figure 1. Locate the ladder section with the stabilizer bracket welded to it (O.). Install the ladder section with the stabilizer bracket welded to it (O.) onto the previously installed second ladder section (N.) by inserting the male end into the female end of the second ladder section (N.) and secure using two (2) 1 3/4" x 5/16" bolts, four washers and two (2) locknuts as shown in Figure 17 (pictured in the photo inset).

STEP 17: Refer to Figure 1. Locate the lower ladder section (P.). Install the lower ladder section (P.) onto the previously installed ladder section with the stabilizer bracket welded to it (O.) by inserting the male end into the female end of the ladder section with the stabilizer bracket welded to it (O.) and secure using two (2) 1 3/4" x 5/16" bolts, four washers and two (2) locknuts as shown in Figure 17 (pictured in the photo inset).

STEP 18: Refer to Figure 1. Locate the criss cross safety straps (Q.). One end of the straps has a sewn in loop. The other end does not have a loop. Wrap the loop end around the tree brace and slip the other end through the loop. Pull tight as shown in Figure 18. Repeat this step for the other criss cross safety strap (Q.) on the opposite side of the stand. GO BACK AND MAKE SURE ALL THE HARDWARE IS TIGHT.

INSTALLING OL' MAN TREESTANDS 20' GRAND DELUXE LADDER



WARNING! You must have at least three (3) adults to install and/or remove this ladder treestand. Failure to follow these instructions may result in serious injury or death!

PLEASE READ THIS MANUAL IN ITS ENTIRETY PRIOR TO USING THIS PRODUCT!

PLEASE READ THIS MANUAL IN ITS ENTIRETY PRIOR TO USING THIS PRODUCT!

PLEASE READ THIS MANUAL IN ITS ENTIRETY PRIOR TO USING THIS PRODUCT!



WARNING! Prior to attempting to use this or any other Ol' Man Treestands product(s) you must take a moment and become familiar with it's setup and installation at ground level. You must practice installing, setting-up and using this product(s) at ground-level prior to attempting to use it at heights above ground-level. Once you have become thoroughly knowledgeable and comfortable with this Ol' Man Treestands product(s) setup, installation and use at ground-level - you're now ready to use it at heights above ground-level. Failure to follow these instructions may result in serious injury or death!



WARNING! STOP NOW!!!! Make sure that you are wearing your Scout, Inc. full-body fall arrest harness. Failure to follow these instructions may result in serious injury or death!



WARNING! Never attempt to access your standing or seating platforms by climbing over and under the folding footrest! Always utilize the folding feature when accessing your stand. Failure to follow these instructions will result in serious injury or death!

STEP 1: Select a straight, healthy tree between 8- to 20-inches in diameter.

STEP 2: With the assistance of two (2) other adults (three adults total), place the base of the ladder approximately four-feet (48") from the base of the tree.



WARNING! You must check the ground under the treestand to make sure it is firm and level. Sloping ground or uneven surfaces (e.g., one foot on a rock) can cause your ladder to tilt or shift off the tree as you climb. Failure to follow these instructions may result in serious injury or death!



WARNING! DO NOT use this, or any other Ol' Man Treestands product(s) to climb utility poles, telephone poles, structural columns or any other man-made structures. Never use this or any other Ol' Man Treestands product(s) around power generation (e.g., transformers, generators, substations, etc.) and/or power transmission equipment. Failure to follow these instructions will result in serious injury or death!

STEP 3: With the assistance of two (2) other adults, gently stand the ladder up while the third person stands on the bottom rung, (so it does not slip) and helps lift and guide the ladder into an erect position against the tree trunk.

STEP 4: Once the ladder is leaning against the tree, step back and check the standing and seating platforms to make sure they are level. To adjust the level of these platforms, move the ladder either closer or further away from the tree trunk depending on the direction the platforms need to be adjusted.

STEP 5: With the standing and seating platforms now level, place your weight on the bottom rung of the lower ladder section (P.) to firmly seat the ladder. Step back once again and check to make sure the standing platform and seating platforms are still level. If not, readjust until these platforms are level.

STEP 6: Locate the previously installed criss cross safety straps (Q.). Cross the straps around the tree trunk as shown in Figure 19. Tie the ends of the criss cross safety straps (Q.) on the fourth ladder rung up from the bottom on the lower ladder section as shown in Figure 20. DO NOT tighten these straps yet.

STEP 7: Refer to Figure 1. Locate the tree stabilizer bar (R.). Install the tree stabilizer bar (R.) by connecting it to the ladder section with the stabilizer bar bracket welded to it (O.). Install using one (1) 2 1/4" x 5/16" bolt, two (2) nylon washers and one (1) locknuts as shown in Figure 21. With the standing and seating platforms level, raise and engage the tree stabilizer bar (R.). Adjust the tree stabilizer bar (S.) by removing the clevis pin and adjusting the tree stabilizer bars (S.) length so the "Y" portion with its teeth contact the tree trunk firmly as shown in Figure 22. Engage the 1" cam buckle strap around the tree trunk and firmly tighten.

STEP 8: With the tree stabilizer bar (S.) installed and tightened, tighten the criss cross safety straps (Q.). Tighten these straps until the ladder stand assembly becomes rigidly attached to the tree. DO NOT overtighten. Make certain the straps are straight without any twists in them.



WARNING! Prior to climbing, make sure that all the ladder sections are firmly connected and the ladder assembly is solidly secured to the tree. Failure to follow these instructions will result in serious injury or death!



WARNING! Prior to attempting to climb a ladder stand for the first time, make certain the feet of the bottom rung ladder section are firmly planted on solid, level ground. If they are not firmly planted on level ground, DO NOT climb the ladder. With the help of three (3) adults, lower the stand and find a suitable location to safely install the ladder stand. Failure to follow these instructions may result in serious injury or death!



FIGURE 19
CROSS SAFETY STRAPS



FIGURE 20
TIE CRISS CROSS SAFETY STRAPS ONTO LADDER



FIGURE 21
INSTALL TREE STABILIZER BAR

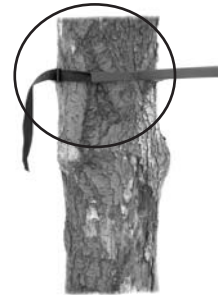

FIGURE 22
STABILIZER BAR FIRMLY CONNECTED TO TREE



WARNING! When climbing to secure the ratchet straps, it is important to lean forward when climbing to keep the stand centered and secure to the tree trunk. DO NOT lean backwards when climbing! Failure to follow these instructions will result in serious injury or death!



WARNING! When climbing, always maintain three points of contact as you ascend (climb up) and while descending (climb down). Failure to maintain three points of contact puts the user at serious risk of bodily injury. Failure to follow these instructions will result in serious injury or death!

PLEASE READ THIS MANUAL IN ITS ENTIRETY PRIOR TO USING THIS PRODUCT!

PLEASE READ THIS MANUAL IN ITS ENTIRETY PRIOR TO USING THIS PRODUCT!



WARNING! As you approach the top of the ladder, attach your Scout, Inc. full-body fall arrest harness tether to the tree trunk as soon as possible. After your tether has been attached to the tree, attach the ratchet straps to secure the top of the stand to the tree. Do not sit or stand on the standing platform until the ratchet straps have been securely fastened. Failure to follow these instructions will result in serious injury or death!

PLEASE READ THIS MANUAL IN ITS ENTIRETY PRIOR TO USING THIS PRODUCT!

PLEASE READ THIS MANUAL IN ITS ENTIRETY PRIOR TO USING THIS PRODUCT!

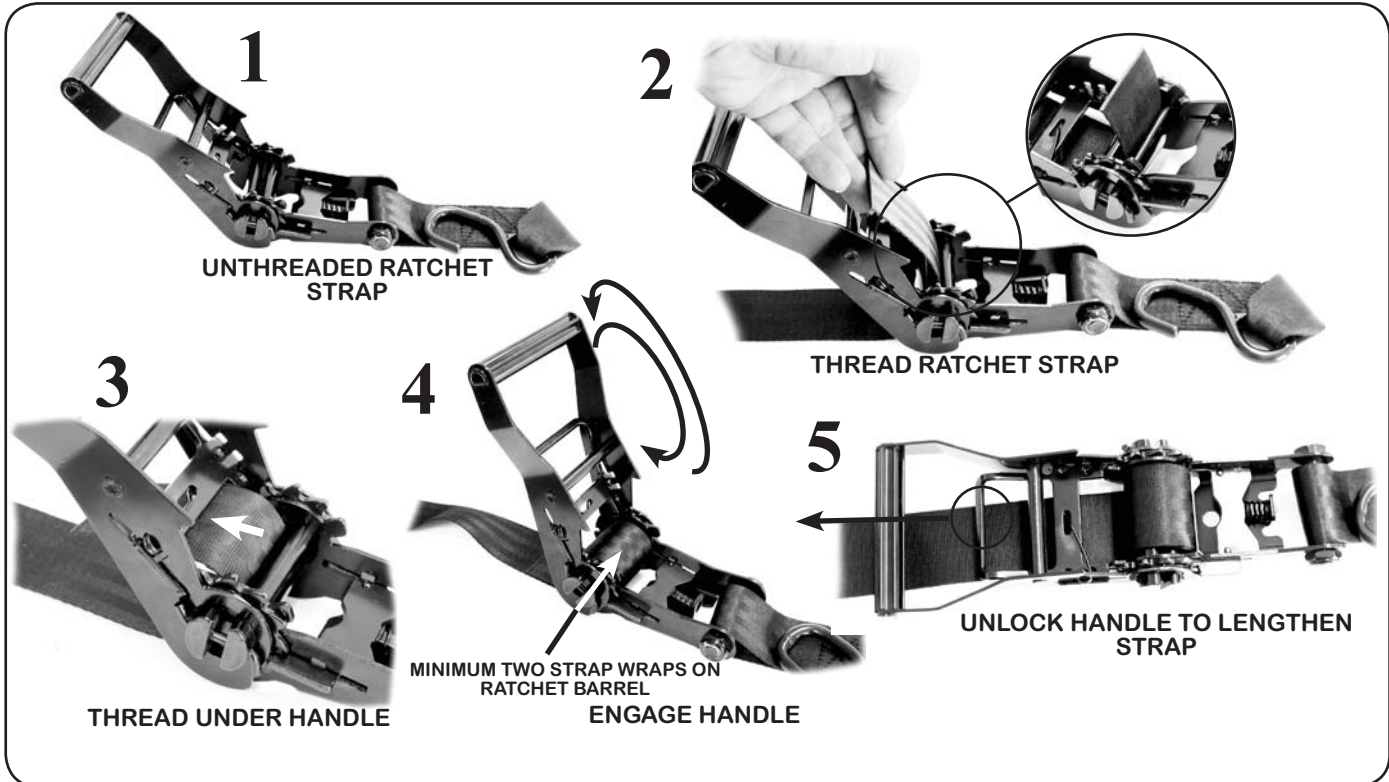

FIGURE 23
THREADING RATCHET STRAP

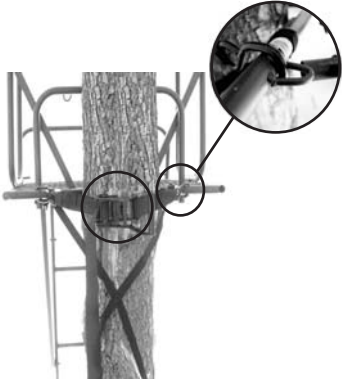

FIGURE 24
INSTALL 4" RATCHET

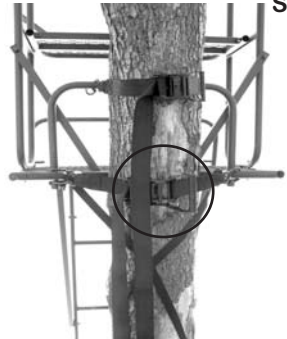

FIGURE 25
INSTALL 3 1/4" RATCHET

STEP 9: Refer to Figure 1. Locate the two (2) ratchet straps (R. & S.). Thread these ratchets in accordance with Figure 23.

STEP 10: With two (2) other adults at the base of the ladder stand holding it steady, climb to a height that allows you to safely attach your Scout, Inc. full-body fall arrest harness tether to the tree trunk as soon as possible. After your tether has been attached to the tree trunk securing your position, attach the 4" ratchet strap to secure the tree brace as shown in Figure 24. To install the 4" ratchet strap (S.), simply wrap the strap around the tree trunk and attach back to the welded receivers as shown in Figure 24. (Refer to Figure 23 for threading instructions). Make sure the 4" ratchet strap (S.) is very tight.

STEP 11: Refer to Figure 1. Locate the 3 1/4" ratchet strap (T.). Install the 3 1/4" ratchet strap (T.) on the upper tree brace (I.) by attaching it to the welded receivers as shown in Figure 25. Make certain that the 3 1/4" ratchet strap (T.) is very tight.

TREESTAND REMOVAL



WARNING! STOP NOW!!!! Make sure that you are wearing your Scout, Inc. full body fall arrest harness! Failure to follow these instructions may result in serious injury or death!



WARNING! When climbing to remove the ratchet straps, it is important to lean forward when climbing to keep the stand centered and secure to the tree trunk. **DO NOT** lean backwards when climbing! Failure to follow these instructions will result in serious injury or death!



WARNING! When climbing, always maintain three points of contact as you ascend (climb up) and while descending (climb down). Failure to maintain three points of contact puts the user at serious risk of bodily injury. Failure to follow these instructions will result in serious injury or death!



WARNING! As you approach the top of the ladder, attach your Scout, Inc. full-body fall arrest harness tether to the tree trunk as soon as possible. Failure to follow these instructions will result in serious injury or death!

PLEASE READ THIS MANUAL IN ITS ENTIRETY PRIOR TO USING THIS PRODUCT!

PLEASE READ THIS MANUAL IN ITS ENTIRETY PRIOR TO USING THIS PRODUCT!

STEP 1: With two (2) other adults at the base of the ladder stand holding it steady, climb to a height that allows you to safely attach your Scout, Inc. full-body fall arrest harness tether to the tree trunk as soon as possible. After your tether has been attached to the tree trunk, disconnect the 4" ratchet strap (S.). We recommend you disconnect one side only and allow the ratchet strap to hang down. Next, disconnect the 3 1/4" ratchet strap (T.).

STEP 2: Disconnect your tether and climb back down to the ground. Remove the criss cross safety straps (Q.) and disconnect the tree stabilizer bar (R.). With the help of two (2) other adults, gently lower the treestand to the ground.

STORAGE AND CARE

Your new Ol' Man Treestands treestand is factory finished with a state-of-the-art powder coating that guarantees years of trouble-free service. It is recommended that you store your treestand out of direct sunlight and out of any other harsh environmental condition(s) that may adversely affect its performance.

IMPORTANT WARRANTY INFORMATION

Ol' Man Treestands warrants this Ol' Man Treestands product against defect(s) in material and workmanship, under proper use and storage for the period of one (1) year from the date of purchase. Proof of purchase, plus, the return of your warranty application card to our home office, is required for any warranty claim. In the event this product is found to be defective within the warranty period, Ol' Man Treestands only obligation and your exclusive remedy shall be replacement or repair of any defective parts at our discretion. To obtain warranty service, please contact Ol' Man Treestands Customer Service at 888-656-2606. Exclusions to this warranty include seat, paint, plastics, webbing and/or defects caused by operator misuse and/or abuse. Limitation to liability include the forgoing warranty is made in lieu of all other warranties, express or implied and Ol' Man Treestands disclaims any implied warranty of merchantability and fitness. Ol' Man Treestands shall not be liable for any damages direct, consequential or incidental arising out of the use or inability of this product.

WARRANTY APPLICATION CARD

I have read and understand the safety, assembly and operating instructions provided with my Ol' Man Treestands treestand. I fully understand the importance of using the TMA compliant full-body fall-arrest safety harness, and realize that if I choose not to use the TMA compliant full-body fall arrest safety harness I am putting myself at an increased risk of injury should an accident occur while I am utilizing this Ol' Man Treestands product(s). I have read the warranty information and know that I can call Ol' Man Treestands at 888-656-2606 with any questions or concerns that I may have about this or any other Ol' Man Treestands product(s). Mail to: OL' MAN TREESTANDS, 2830 Plant Street, Tallahassee, Florida, 32304.

NAME _____ PURCHASED WHERE _____

ADDRESS _____

CITY/STATE/ZIP _____

PURCHASE DATE _____

PRODUCT _____



PLEASE READ THIS MANUAL IN ITS ENTIRETY PRIOR TO USING THIS PRODUCT!

PLEASE READ THIS MANUAL IN ITS ENTIRETY PRIOR TO USING THIS PRODUCT!

PLEASE READ THIS MANUAL IN ITS ENTIRETY PRIOR TO USING THIS PRODUCT!